

# GFR Series - 1 Pole+N, B Trip, 30 mA 277V AC Ground Fault Relay with Overload Protection (RCBO)

The GFR Series is a combined Equipment Ground Fault Relay and Supplementary Protector (RCBO), featuring dual pole switching (live and neutral) and designed to provide protection against overloads and AC ground faults (residual current faults) as well as pulsating DC ground faults.



### Ordering Information

Rated Current	Type/ Cat. No.	Rated Voltage
5.0A	GFR2B05030	277V AC
6.0A	GFR2B06030	277V AC
8.0A	GFR2B08030	277V AC
10A	GFR2B10030	277V AC
12A	GFR2B12030	277V AC
13A	GFR2B13030	277V AC
15A	GFR2B15030	277V AC
16A	GFR2B16030	277V AC
20A	GFR2B20030	277V AC
25A	GFR2B25030	277V AC
30A	GFR2B30030	277V AC
32A	GFR2B32030	277V AC
35A	GFR2B35030	277V AC
40A	GFR2B40030	277V AC

**UL 1077**  
Ground Fault Relay  
with Overload Protection

### GFR Series RCBO Overload Trip Curves

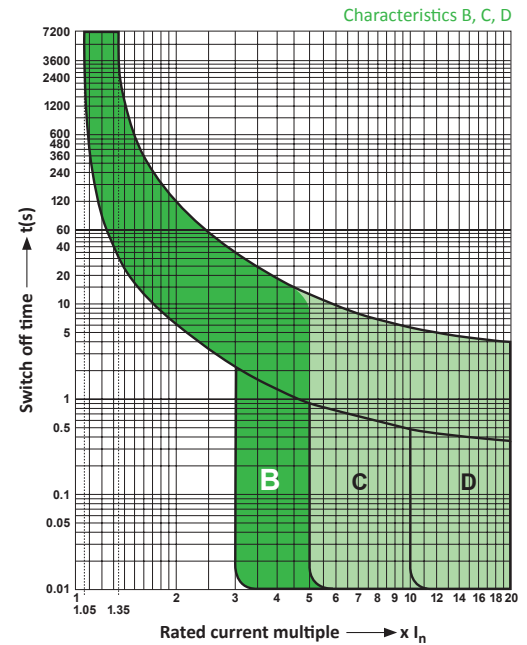

### Technical Specification

Number of Poles	1+N
Voltage Rating (maximum)	277V AC
Ground Fault Sensitivity Level	30 mA
Short Circuit Withstand Rating	10 kA
Rated Frequency	50/60Hz
Trip Characteristic	B
Cable Size & Tightening Torque	Stranded Wire: 16 - 3 AWG (1.5 mm <sup>2</sup> - 25 mm <sup>2</sup> ) @ 17.5 lb-in (2.0 Nm) Solid Wire: 16 - 10 AWG (1.5 mm <sup>2</sup> - 5.5 mm <sup>2</sup> ) @ 17.5 lb-in (2.0 Nm) 18 - 16 AWG (1 mm <sup>2</sup> - 1.5 mm <sup>2</sup> ) @ 25 lb-in (2.8 Nm)
Electrical Life	6000 Switching Operations
Mechanical Life	10000 Switching Operations

**Dimensions**  
(to convert to inches multiply by 0.03937)

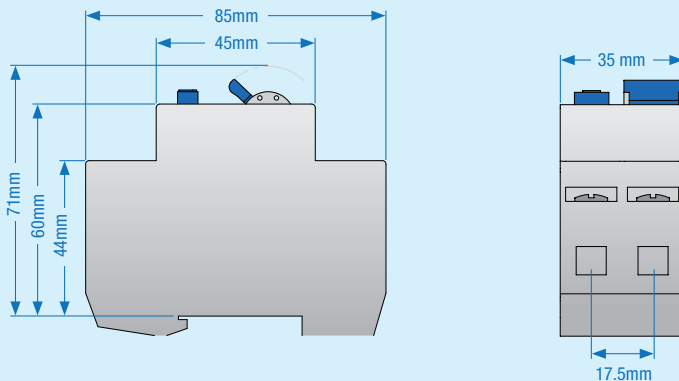

**Weight** 217 g

### GFR Series RCBO Short Circuit Withstand Rating

V	I	IR	Backup
1+N Pole	≤20A	10kA	None
277V AC	>20A	10kA	Class J Fuse 250A or lower Altech L Series Branch Circuit Breaker Altech R Series Supplementary Protector

### GFR Series RCBO Ground Fault Trip Curve

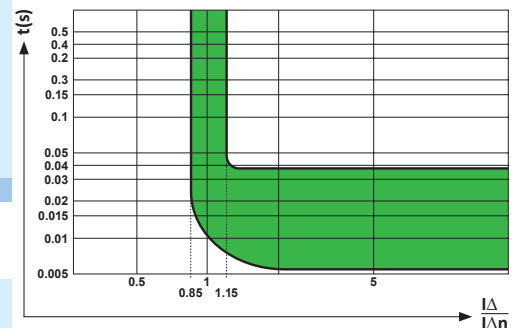

GFR Series - 1 Pole+N, B Trip, 30 mA  
 Applicable voltage systems and wiring examples.

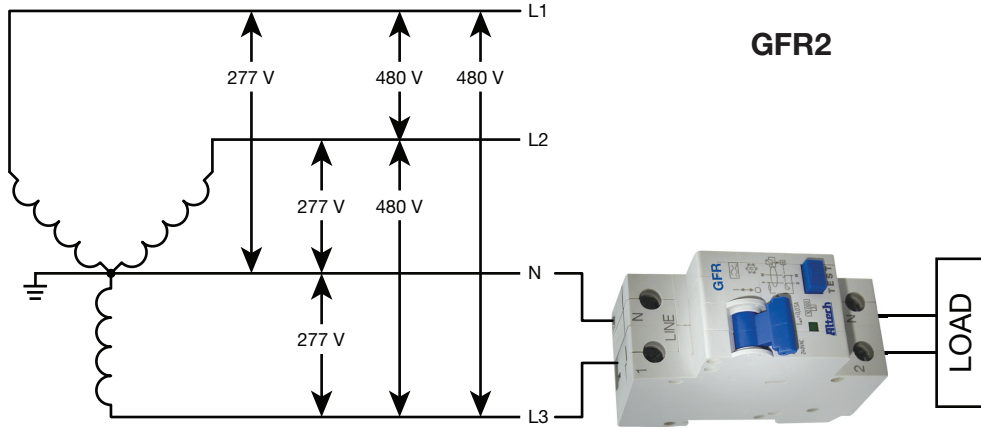

**GFR2**

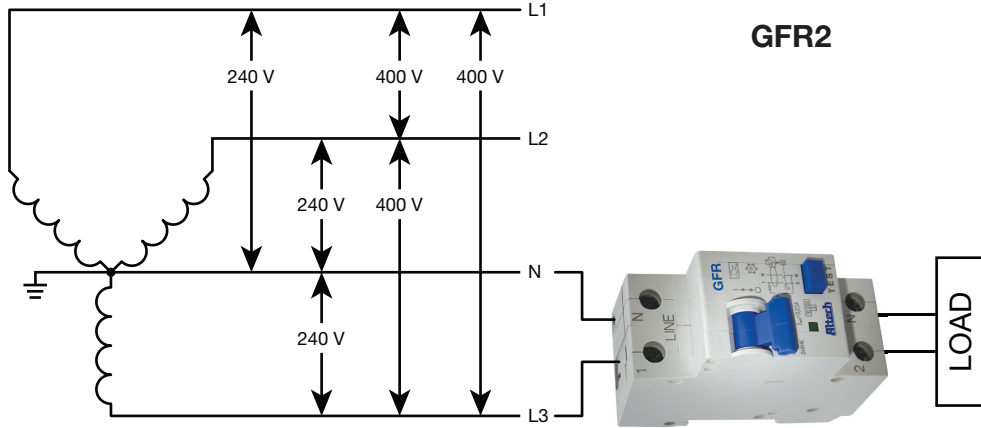

**GFR2**

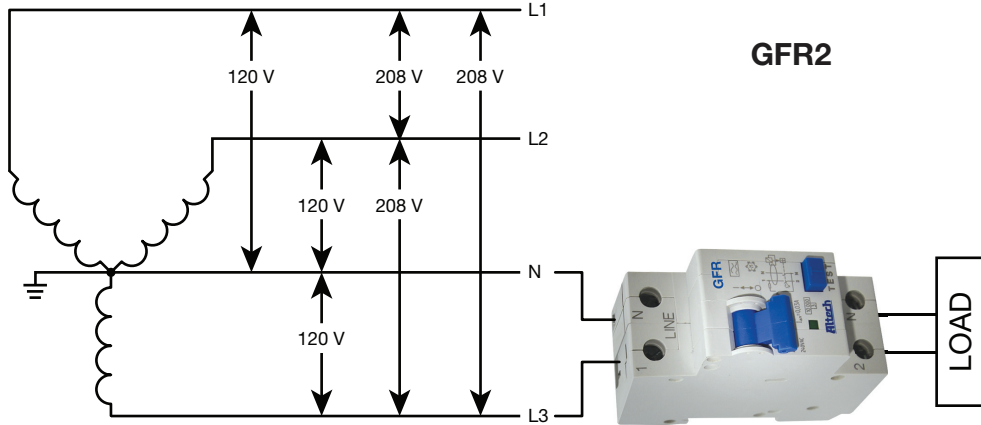

**GFR2**

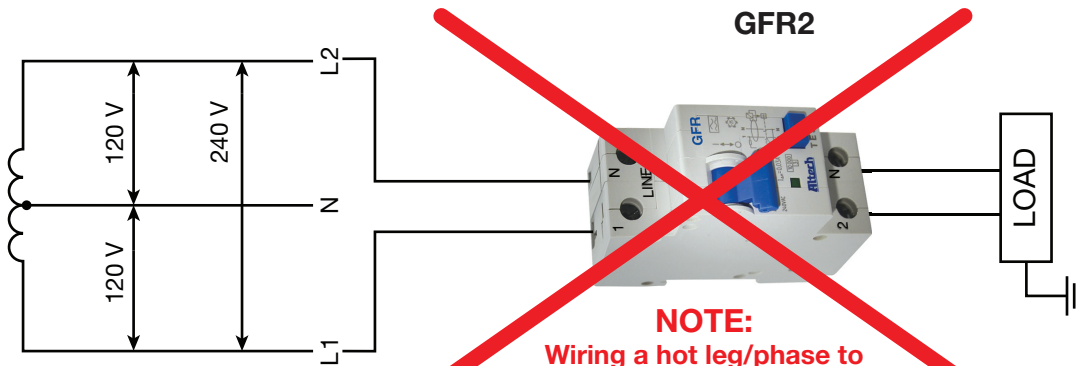

**GFR2**

**NOTE:**  
 Wiring a hot leg/phase to  
 N terminal is not permitted.

**UL 1077**  
 Ground Fault Relay  
 with Overload Protection